

## VYHLÁSENIE O PARAMETROCH

### DoP 0192

pre oceľovú kotvu fischer FBN II, FBN II R (mechanická kotva do betónu)

SK

1. <u>Jedinečný identifikačný kód typu výrobku:</u>	<b>DoP 0192</b>		
2. <u>Zamýšľané použitie/použitia:</u>	<b>Dodatočné upevnenie v betóne bez trhlín.</b>		
3. <u>Výrobca:</u>	<b>Pozri prílohu, najmä prílohy B1- B3 fischerwerke GmbH &amp; Co. KG, Klaus-Fischer-Str. 1, 72178 Waldachtal, Nemecko</b>		
4. <u>Spĺnomocnený zástupca:</u>	–		
5. <u>Systém(-y) posudzovania a overovania nemennosti parametrov:</u>	1		
6. <u>Európsky hodnotiaci dokument:</u> Európske technické posúdenie: Orgán technického posudzovania: Notifikovaný(-é) subjekt(-y):	<b>EAD 330232-01-0601, (Edition 12/ 2019) ETA-07/0211; 2020-07-13 DIBt- Deutsches Institut für Bautechnik 1343 MPA Darmstadt / 2873 TU Darmstadt</b>		
7. <u>Deklarované parametre:</u> <b>Mechanická odolnosť a stabilita (BWR 1)</b> Charakteristická odolnosť v ťahu (statické a kvázistatické zaťaženie):	Odolnosť voči porušeniu ocele: Odolnosť voči porušeniu vytiahnutím:	Prílohy C1 Prílohy C1	$E_s = 210\,000\text{ MPa}$
	Odolnosť voči porušeniu betónového kužela: Robustnosť:	Prílohy C1 Prílohy C1	$k_{cr,N} = \text{NPD}$
	Minimálna vzdialenosť od okraj a osová Vzdialenosť od okraja voči rozštiepniu pri zaťažení.	Prílohy C3 Prílohy C1	
Charakteristická odolnosť v šmyku (statické a kvázistatické zaťaženie), Metóda A:	Odolnosť voči porušeniu ocele: (Zaťaženie šmykom) Odolnosť voči vylomeniu:	Prílohy C2 Prílohy C2	
Charakteristická odolnosť a posuny pre seizmické výkonnostné kategórie C1 a C2:	Odolnosť pri zaťažení ťahom, kategória C1: Odolnosť pri zaťažení ťahom, kategória C2: Odolnosť pri zaťažení šmykom, posuny, kategória C1: Odolnosť pri zaťažení šmykom, posuny, kategória C2: Faktor prstencovej medzery:	NPD NPD NPD NPD NPD	
Charakteristická odolnosť pre zjednodušený návrh:	Metóda B: Metóda C:	NPD NPD	
Posuny a životnosť:	Posuny pri statickom a kvázistatickom zaťažení: životnosť:	Prílohy C3 Prílohy A4, B1	
<b>Bezpečnosť v prípade požiaru (BWR 2)</b> Reakcia na oheň: Odolnosť proti ohňu:	Trieda (A1) Požiarna odolnosť voči porušeniu ocele (Zaťaženie Požiarna odolnosť voči vytiahnutiu (Zťaženie Požiarna odolnosť voči porušeniu ocele (Zaťaženie	NPD NPD NPD	



8. Vhodná technická dokumentácia a/alebo špecifická technická dokumentácia: -

Uvedené parametre výrobku sú v zhode so súborom deklarovaných parametrov. Toto vyhlásenie o parametroch sa v súlade s nariadením (EÚ) č. 305/2011 vydáva na výhradnú zodpovednosť uvedeného výrobcu.

Podpísal(-a) za a v mene výrobcu:

*ppa. Thilo P.*

Thilo Pregartner, Dr.-Ing.  
Tumlingen, 2020-07-27

*i.V. P. Sch.*

Peter Schillinger, Dipl.-Ing.

Toto vyhlásenie o vlastnostiach bolo vyhotovené v rôznych jazykoch. V prípade, že dôjde k rozdielnemu výkladu má anglická verzia vždy prednosť.

Príloha obsahuje dobrovoľné a doplnujúce informácie v anglickom jazyku. Tieto vychádzajú zo zákonom stanovených požiadaviek (jazykovo neutrálnych).

## Specific Part

### 1 Technical description of the product

The fischer Bolt anchor FBN II and FBN II R is an anchor made of zinc plated, hot-dip galvanised or stainless steel which is placed into a drilled hole and anchored by torque-controlled expansion.

The product description is given in Annex A.

### 2 Specification of the intended use in accordance with the applicable European Assessment Document

The performances given in Section 3 are only valid if the fastener is used in compliance with the specifications and conditions given in Annex B.

The verifications and assessment methods on which this European Technical Assessment is based lead to the assumption of a working life of the fastener of at least 50 years. The indications given on the working life cannot be interpreted as a guarantee given by the producer, but are to be regarded only as a means for choosing the right products in relation to the expected economically reasonable working life of the works.

### 3 Performance of the product and references to the methods used for its assessment

#### 3.1 Mechanical resistance and stability (BWR 1)

Essential characteristic	Performance
Characteristic resistance to tension load (static and quasi-static loading)	See Annex C 3, C 1
Characteristic resistance to shear load (static and quasi-static loading)	See Annex C 2
Displacements (static and quasi-static loading)	See Annex C 3
Characteristic resistance and displacements for seismic performance categories C1 and C2	No performance assessed
Durability	See Annex B 1

#### 3.2 Safety in case of fire (BWR 2)

Essential characteristic	Performance
Reaction to fire	Class A1
Resistance to fire	No performance assessed

### 4 Assessment and verification of constancy of performance (AVCP) system applied, with reference to its legal base

In accordance with the European Assessment Document EAD 330232-01-0601 the applicable European legal act is: [96/582/EC].

The system to be applied is: 1

Cone bolt manufactured by cold - forming:

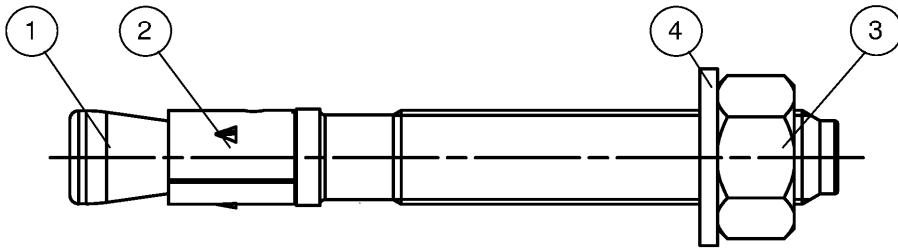

Cone bolt manufactured by turning:

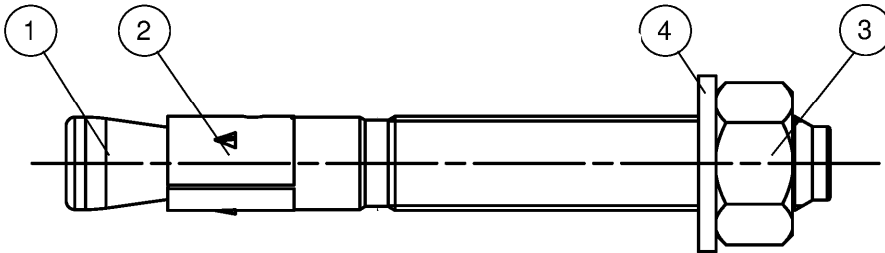

- ① Cone bolt (cold – formed or turned)
- ② Expansion sleeve
- ③ Hexagon nut
- ④ Washer

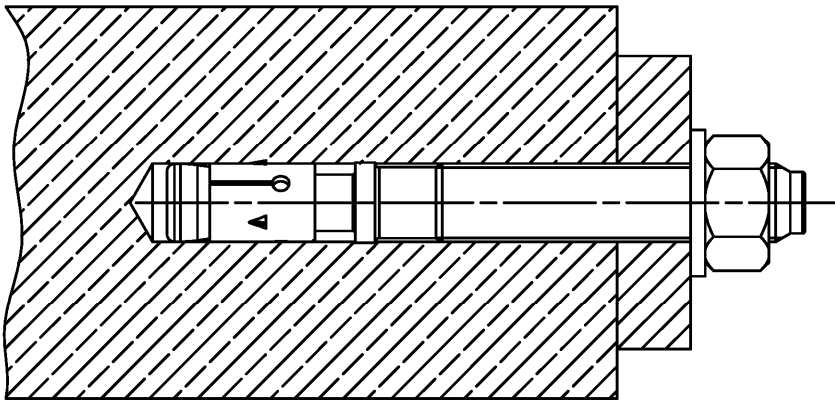

(Fig. not to scale)

fischer Bolt Anchor FBN II, FBN II R

**Product description**  
Installed condition

**Annex A 1**

Appendix 2/ 11

## FBN II for use with standard and reduced anchorage depth ( $h_{ef, sta}$ and $h_{ef, red}$ )

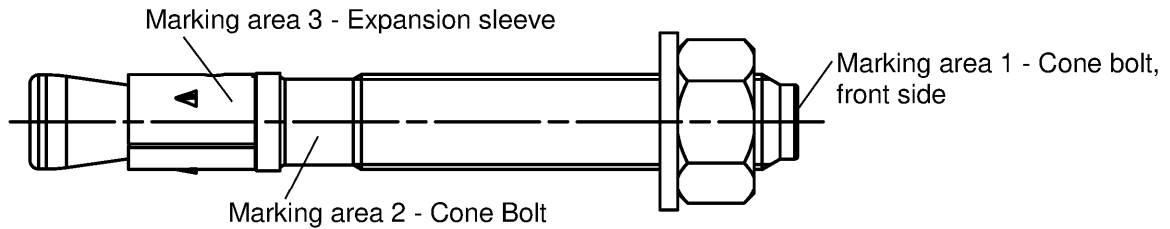

Product label, example:

FBN II 12/10 R

Brand | type of fastener  
placed at marking area 2 or 3

Thread size / max. thickness of the fixture ( $t_{fix}$ ) for  $h_{ef, sta}$   
identification R or HDG placed at marking area 2

**Table A2.1:** Letter-code on marking area 1 and maximum thickness of fixture  $t_{fix}$  [mm]:

marking		A	B	C	D	E	F	G	H	I	K	L	M	N	O	P	R	S	T	U	V	W	X	Y	Z
max. $t_{fix}$ for $h_{ef, sta}$	M6-M20	5	10	15	20	25	30	35	40	45	50	60	70	80	90	100	120	140	160	180	200	250	300	350	400
max. $t_{fix}$ for $h_{ef, red}$	M8, M10	15	20	25	30	35	40	45	50	55	60	70	80	90	100	110	130	150	170	190	210	260	310	360	410
	M12, M16	20	25	30	35	40	45	50	55	60	65	75	85	95	105	115	135	155	175	195	215	265	315	365	415
	M20	30	35	40	45	50	55	60	65	70	75	85	95	105	115	125	145	165	185	205	225	275	325	375	425

## FBN II K for use with reduced anchorage depth only ( $h_{ef, red}$ ):

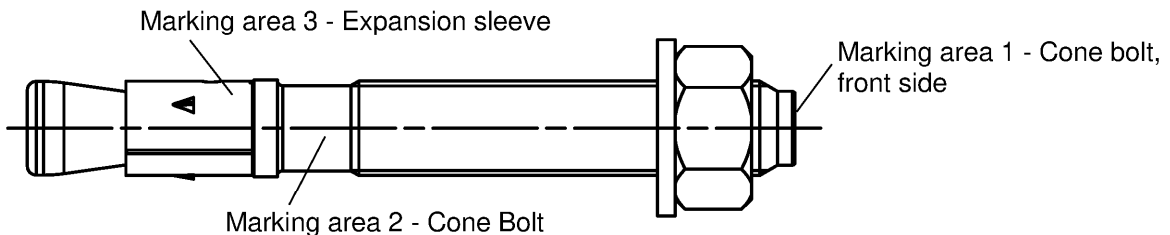

Product label, example:

FBN II 12/10 K R

Brand | type of fastener  
placed at marking area 2 or 3

Thread size / max. thickness of the fixture ( $t_{fix}$ )  
identification K for  $h_{ef, red}$   
identification R or HDG placed on marking area 2

**Table A2.2:** Letter-code on marking area 1 and maximum thickness of fixture  $t_{fix}$  [mm]:

Markierung		-A-	-B-	-C-	-D-	-E-	-F-	-G-	-H-	-I-	-K-	-L-	-M-	-N-	-O-	-P-	-R-	-S-	-T-	-U-	-V-	-W-	-X-	-Y-	-Z-
max. $t_{fix}$ for $h_{ef, red}$	M8-M20	5	10	15	20	25	30	35	40	45	50	60	70	80	90	100	120	140	160	180	200	250	300	350	400

Identification for  $h_{ef, red}$  is the letter-code between 2 hyphen

(Fig. not to scale)

fischer Bolt Anchor FBN II, FBN II R

**Product description**  
Product label and letter code

**Annex A 2**

Appendix 3/ 11

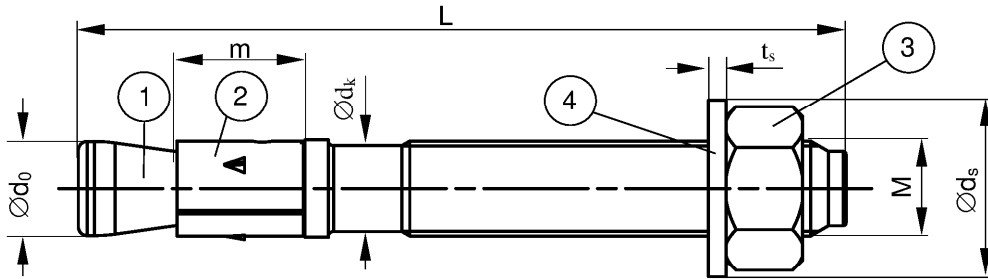

**Table A3.1:** Anchor dimensions [mm]

Part	Designation		FBN II, FBN II R					
			M6	M8	M10	M12	M16	M20
1	Cone bolt	M	M6	M8	M10	M12	M16	M20
		$\varnothing d_0$	5,9	7,9	9,9	11,9	15,9	19,6
		$\varnothing d_k$	5,2	7,1	8,9	10,8	14,5	18,2
2	Expansion sleeve	m	10	11,5	13,5	16,5	21,5	33,5
3	Hexagon nut	SW	10	13	17	19	24	30
4	Washer	$t_s$	1,0	1,4	1,8	2,3	2,7	2,7
		$\varnothing d_s$	11,5	15	19	23	29	36
Thickness of fixture		$t_{fix}$	0	0	0	0	0	0
			200	200	250	300	400	500
Length of fastener		$L_{min}$	45	56	71	86	120	139
		$L_{max}$	245	261	316	396	520	654

(Fig. not to scale)

fischer Bolt Anchor FBN II, FBN II R

**Product description**  
Dimensions

**Annex A 3**

Appendix 4/ 11

**Table A4.1: Materials FBN II (zinc plated  $\geq 5\mu\text{m}$ , ISO 4042:2018)**

Part	Designation	Material
1	Cone bolt	Cold form steel or free cutting steel
2	Expansion sleeve	Cold strip, EN 10139:2016 <sup>1)</sup>
3	Hexagon nut	Steel, property class min. 8, EN ISO 898-2:2012
4	Washer	Cold strip, EN 10139:2013

<sup>1)</sup> Optional stainless steel EN 10088:2014

**Table A4.2: Materials FBN II HDG (hot-dip galvanised  $\geq 50\mu\text{m}$ , ISO 10684: 2004 <sup>2)</sup>)**

Part	Designation	Material
1	Cone bolt	Cold form steel or free cutting steel
2	Expansion sleeve	Stainless steel EN 10088:2014
3	Hexagon nut	Steel, property class min. 8, EN ISO 898-2:2012
4	Washer	Cold strip, EN 10139:2016

<sup>1)</sup> Alternative method sherardized  $\geq 50\mu\text{m}$ , EN 13811:2003

**Table A4.3: Materials FBN II R**

Part	Designation	Material
1	Cone bolt	Stainless steel EN 10088:2014
2	Expansion sleeve	Stainless steel EN 10088:2014
3	Hexagon nut	Stainless steel EN 10088:2014 ISO 3506-2: 2009; property class min. 70
4	Washer	Stainless steel EN 10088:2014

fischer Bolt Anchor FBN II, FBN II R

**Product description**  
Materials

**Annex A 4**

Appendix 5/ 11

## Specifications of intended use

### Anchorage subject to:

fischer Bolt Anchor FBN II, FBN II R		M6 <sup>1)</sup>	M8 <sup>1)</sup>	M10	M12	M16	M20
Material	Steel	Zinc plated			✓		
		Hot-dip galvanized HDG	-2)		✓		
	Stainless steel	R			✓		
Static and quasi-static loads					✓		
Reduced anchorage depth			-2)			✓	
Uncracked concrete					✓		

<sup>1)</sup> Use of FBN II 6 (gvz/R) and FBN II 8 (gvz/HDG/R) with  $h_{ef} = 30\text{mm}$  restricted to anchoring of structural components which are statically indeterminate

<sup>2)</sup> Anchor type not part of the assessment

#### Base materials:

- Reinforced or unreinforced normal concrete without fibres of strength classes C20/25 to C50/60 according to EN 206:2013+A1:2016

#### Use conditions (Environmental conditions):

- Structures subject to dry internal conditions:
- For all other conditions according to EN 1993-1-4:2015-10 corresponding to corrosion resistance class CRC III

**FBN II, FBN II HDG**

**FBN II R**

#### Design:

- Anchorage are to be designed under the responsibility of an engineer experienced in anchorages and concrete work
- Verifiable calculation notes and drawings are to be prepared taking account of the loads to be anchored. The position of the anchor is indicated on the design drawings (e.g. position of the anchor relative to reinforcement or to supports, etc.)
- Design of fastenings according to EN 1992-4:2018 and TR 055

fischer Bolt Anchor FBN II, FBN II R

**Intended Use**  
Specifications

**Annex B 1**

Appendix 6/ 11



**Table B2.1:** Installation parameters

Type of anchor / size <b>FBN II, FBN II R</b>	<b>M6</b>	<b>M8</b>	<b>M10</b>	<b>M12</b>	<b>M16</b>	<b>M20</b>
Nominal drill hole diameter $d_0 =$	6	8	10	12	16	20
Cutting diameter of drill bit $d_{cut} \leq$	6,45	8,45	10,45	12,50	16,50	20,55
Standard anchorage depth $h_{ef,sta} =$	30 <sup>1)</sup>	40	50	65	80	105
Reduced anchorage depth $h_{ef,red} =$ [mm]	- <sup>2)</sup>	30 <sup>1)</sup>	40	50	65	80
Standard drill hole depth $h_{1,sta} \geq$	40	56	68	85	104	135
Reduced drill hole depth $h_{1,red} \geq$	- <sup>2)</sup>	46 <sup>1)</sup>	58	70	89	110
Diameter of clearance hole in the fixture $d_f \leq$	7	9	12	14	18	22
Required torque moment FBN II (zinc plated)	4	15	30	50	100	200
Required torque moment FBN II (hot-dip galvanized) $T_{inst} =$ [Nm]	- <sup>3)</sup>	15	30	40	70	200
Required torque moment FBN II R	4	10	20	35	80	150

- 1) Use restricted to anchoring of structural components which are statically indeterminate
- 2) No performance assessed
- 3) Anchor type not part of the assessment

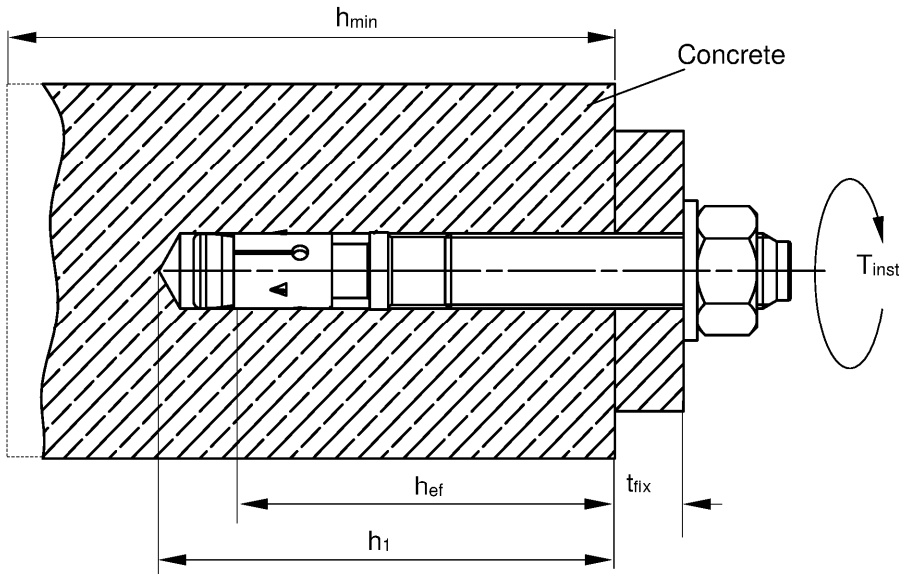

- $h_{ef}$  = Effective embedment depth
- $t_{fix}$  = Thickness of the fixture
- $h_1$  = Depth of drill hole to deepest point
- $h_{min}$  = Minimum thickness of concrete member
- $T_{inst}$  = Required setting torque

(Fig. not to scale)

fischer Bolt Anchor FBN II, FBN II R

**Intended Use**  
Installation parameters

**Annex B 2**

Appendix 7/ 11

## Installation instructions

- Fastener installation carried out by appropriately qualified personnel and under the supervision of the person responsible for technical matters of the site
- Use of the fastener only as supplied by the manufacturer without exchanging the components of the fastener
- Checking before placing the fastener to ensure that the strength class of the concrete in which the fastener is to be placed is in the range given and is not lower than that of the concrete to which the characteristic loads apply
- Check of concrete being well compacted, e.g. without significant voids
- Hammer or hollow drilling
- Drill hole created perpendicular  $\pm 5^\circ$  to concrete surface, positioning without damaging the reinforcement
- In case of aborted hole: new drilling at a minimum distance twice the depth of the aborted drill hole or smaller distance if the aborted drill hole is filled with high strength mortar and if under shear or oblique tension load it is not in the direction of load application

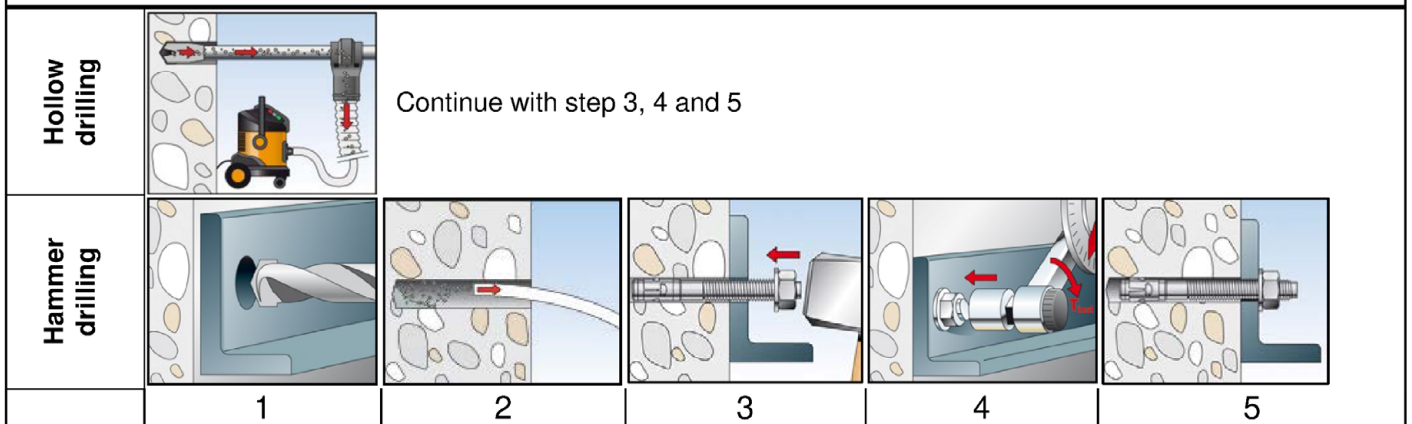

No.	Description	
1	Create drill hole with hammer drill	Create drill hole with hollow drill and vacuum cleaner
2	Clean drill hole	-
3	Set anchor	
4	Expand anchor with prescribed installation torque $T_{inst}$	
5	Finished installation	

### Types of drills

Hammer drill



Hollow drill



fischer Bolt Anchor FBN II, FBN II R

**Intended Use**  
Installation instructions

**Annex B 3**

Appendix 8/ 11

**Table C1.1:** Characteristic values of **tension** resistance under static and quasi-static action

Type of anchor / size			M6	M8	M10	M12	M16	M20
<b>Steel failure for standard and reduced anchorage depth FBN II</b>								
Characteristic resistance <b>FBN II</b>	$N_{Rk,s}$	[kN]	8,3	16,5	27,2	41,6	77,9	107
Partial factor	$\gamma_{Ms}^1$	[-]	1,5	1,4	1,4	1,4	1,5	1,5
<b>Steel failure for standard and reduced anchorage depth FBN II R</b>								
Characteristic resistance <b>FBN II R</b>	$N_{Rk,s}$	[kN]	10,6	16,5	27,2	41,6	78	111
Partial factor	$\gamma_{Ms}^1$	[-]	1,5	1,4	1,4	1,4	1,4	1,5
<b>Pullout failure for standard anchorage depth FBN II, FBN II R</b>								
Characteristic resistance C20/25	$N_{Rk,p}$	[kN]	6 <sup>4)</sup>	12,5	17,4	25,8	35,2	52,9
<b>Pullout failure for reduced anchorage depth FBN II, FBN II R</b>								
Characteristic resistance C20/25	$N_{Rk,p}$	[kN]	- <sup>5)</sup>	6 <sup>4)</sup>	12,5	17,4	25,8	35,2
Increasing factors for $N_{Rk,p}$	$\psi_c$	C25/30	1,12					
		C30/37	1,22					
		C35/45	1,32					
		C40/50	1,41					
		C45/55	1,50					
		C50/60	1,58					
Installation factor	$\gamma_{inst}$	[-]	1,0					
<b>Concrete cone and splitting failure for standard anchorage depth FBN II, FBN II R</b>								
Effective anchorage depth	$h_{ef, sta}$	[mm]	30 <sup>4)</sup>	40	50	65	80	105
Factor for uncracked concrete	$k_{Ucr,N}$	[-]	11,0 <sup>2)</sup>					
Spacing	$s_{cr,N}$	[mm]	3 $h_{ef, sta}$					
Edge distance	$c_{cr,N}$		1,5 $h_{ef, sta}$					
Spacing (splitting failure)	$s_{cr,sp}$		130 <sup>4)</sup>	190	200	290	350	370
Edge distance (splitting failure)	$c_{cr,sp}$		65 <sup>4)</sup>	95	100	145	175	185
Characteristic resistance to splitting	$N_{Rk,sp}^0$	[kN]	min $\{N_{Rk,c}^0, N_{Rk,p}\}^3$					
<b>Concrete cone and splitting failure for reduced anchorage depth FBN II, FBN II R</b>								
Effective anchorage depth	$h_{ef, red}$	[mm]	- <sup>5)</sup>	30 <sup>4)</sup>	40	50	65	80
Factor for uncracked concrete	$k_{Ucr,N}$	[-]	11,0 <sup>2)</sup>					
Spacing	$s_{cr,N}$	[mm]	3 $h_{ef, red}$					
Edge distance	$c_{cr,N}$		1,5 $h_{ef, red}$					
Spacing (splitting failure)	$s_{cr,sp}$		- <sup>5)</sup>	190 <sup>4)</sup>	200	290	350	370
Edge distance (splitting failure)	$c_{cr,sp}$		- <sup>5)</sup>	95 <sup>4)</sup>	100	145	175	185

<sup>1)</sup> In absence of other national regulations

<sup>2)</sup> Based on concrete strength as cylinder strength

<sup>3)</sup>  $N_{Rk,c}^0$  according to EN 1992-4:2018

<sup>4)</sup> Use restricted to anchoring of structural components which are statically indeterminate

<sup>5)</sup> No performance assessed

fischer Bolt Anchor FBN II, FBN II R

**Performances**  
Characteristic values of **tension** resistance

**Annex C 1**

Appendix 9/ 11

**Table C2.1:** Characteristic values of **shear** resistance under static and quasi-static action

Type of anchor / size		M6	M8	M10	M12	M16	M20
Installation Factor	$\gamma_{inst}$ [-]	1,0					
<b>Steel failure without lever arm for standard and reduced anchorage depth</b>							
Characteristic resistance	$\frac{\text{FBN II}}{\text{FBN II R}} V_{Rk,s}^0$ [kN]	6,0 <sup>2)</sup>	13,3	21,0	31,3	55,1	67
		5,3 <sup>2)</sup>	12,8	20,3	27,4	51	86
<b>Steel failure with lever arm for standard anchorage depth</b>							
Characteristic bending moment	$\frac{\text{FBN II}}{\text{FBN II R}} M_{Rk,s}^0$ [Nm]	9,4 <sup>2)</sup>	26,2	52,3	91,6	232,2	422
		8 <sup>2)</sup>	26	52	85	216	454
<b>Steel failure with lever arm for reduced anchorage depth</b>							
Characteristic bending moment	$\frac{\text{FBN II}}{\text{FBN II R}} M_{Rk,s}^0$ [Nm]	- <sup>3)</sup>	19,9 <sup>2)</sup>	45,9	90,0	226,9	349
		- <sup>3)</sup>	21 <sup>2)</sup>	47	85	216	353
Partial factor steel failure	$\gamma_{Ms}^{1)}$ [-]	1,25					
Factor for ductility	$k_7$ [-]	1,0					
<b>Concrete pryout failure for standard anchorage depth FBN II, FBN II R</b>							
Factor for pryout failure	$k_8$ [-]	1,4	1,8	2,1	2,3	2,3	2,3
<b>Concrete pryout failure for reduced anchorage depth FBN II, FBN II R</b>							
Factor for pryout failure	$k_8$ [-]	- <sup>3)</sup>	1,8	2,1	2,3	2,3	2,3
<b>Concrete edge failure for standard anchorage depth FBN II, FBN II R</b>							
Effective length of anchor	$l_{f,sta}$ [mm]	30 <sup>2)</sup>	40	50	65	80	105
Effective diameter of anchor	$d_{nom}$	6	8	10	12	16	20
<b>Concrete edge failure for reduced anchorage depth FBN II, FBN II R</b>							
Effective length of anchor	$l_{f,red}$ [mm]	- <sup>3)</sup>	30 <sup>2)</sup>	40	50	65	80
Effective diameter of anchor	$d_{nom}$	- <sup>3)</sup>	8	10	12	16	20

<sup>1)</sup> In absence of other national regulations

<sup>2)</sup> Use restricted to anchoring of structural components which are statically indeterminate

<sup>3)</sup> No performance assessed

fischer Bolt Anchor FBN II, FBN II R

**Performances**  
Characteristic values of **shear** resistance

**Annex C 2**

Appendix 10/ 11

**Table C3.1:** Minimum thickness of concrete members, minimum spacing and minimum edge distance

Type of anchor / size <b>FBN II, FBN II R</b>			<b>M6</b>	<b>M8</b>	<b>M10</b>	<b>M12</b>	<b>M16</b>	<b>M20</b>
<b>Standard anchorage depth</b>	Effective anchorage depth	$h_{ef, sta}$	30 <sup>2)</sup>	40	50	65	80	105
	Minimum thickness of member	$h_{min}$	100	100	100	120	160	200
	Minimum spacing	$s_{min}$ [mm]	40	40	50 (70 <sup>1)</sup> )	70	90 (120 <sup>1)</sup> )	120
	Minimum edge distance	$c_{min}$	40	40 (45 <sup>1)</sup> )	50 (55 <sup>1)</sup> )	70	90 (80 <sup>1)</sup> )	120
<b>Reduced anchorage depth</b>	Effective anchorage depth	$h_{ef, red}$	- <sup>3)</sup>	30 <sup>2)</sup>	40	50	65	80
	Minimum thickness of member	$h_{min}$	- <sup>3)</sup>	100	100	100	120	160
	Minimum spacing	$s_{min}$ [mm]	- <sup>3)</sup>	40 (50 <sup>1)</sup> )	50	70	90	120 (140 <sup>1)</sup> )
	Minimum edge distance	$c_{min}$	- <sup>3)</sup>	40 (45 <sup>1)</sup> )	80	100	120	120

<sup>1)</sup> Values for FBN II R

<sup>2)</sup> Use restricted to anchoring of structural components which are statically indeterminate

<sup>3)</sup> No performance assessed

**Table C3.2:** Displacements under static and quasi static **tension** loads

Type of anchor / size <b>FBN II, FBN II R</b>			<b>M6</b>	<b>M8</b>	<b>M10</b>	<b>M12</b>	<b>M16</b>	<b>M20</b>
Standard anchorage depth	$h_{ef, sta}$	[mm]	30	40	50	65	80	105
Tension load C20/25	N	[kN]	2,8	6,1	8,5	12,6	17,2	25,8
Displacements	$\delta_{N0}$	[mm]	1,9	0,6	0,9	1,5 (1,9 <sup>1)</sup> )	1,8	1,8 (2,0 <sup>1)</sup> )
	$\delta_{N\infty}$		3,1 (2,7 <sup>1)</sup> )					
Reduced anchorage depth	$h_{ef, red}$		- <sup>2)</sup>	30	40	50	65	80
Tension load C20/25	N	[kN]	- <sup>2)</sup>	2,8	6,1	8,5	12,6	17,2
Displacements	$\delta_{N0}$	[mm]		0,4	0,7	0,7	0,9	1,0
	$\delta_{N\infty}$		1,6 (1,7 <sup>1)</sup> )					

<sup>1)</sup> Values for FBN II R

<sup>2)</sup> No performance assessed

**Table C3.3:** Displacements under static and quasi static **shear** loads

Type of anchor / size <b>FBN II, FBN II R</b>			<b>M6</b>	<b>M8</b>	<b>M10</b>	<b>M12</b>	<b>M16</b>	<b>M20</b>
Shear load FBN II	V	[kN]	3,4	7,6	12,0	17,9	31,5	38,2
Displacements FBN II	$\delta_{v0}$	[mm]	0,7	1,5	1,6	2,0	3,0	2,6
	$\delta_{v\infty}$		1,1	2,3	2,4	3,0	4,5	3,9
Shear load FBN II R	V	[kN]	3,0	7,3	11,6	15,7	29,1	49,0
Displacements FBN II R	$\delta_{v0}$	[mm]	1,5	1,4	2,1	2,6	2,7	4,6
	$\delta_{v\infty}$		2,3	2,2	3,2	3,9	4,1	7,0

fischer Bolt Anchor FBN II, FBN II R

**Performances**

Minimum thickness of concrete members, minimum spacing and minimum edge distance  
Displacements due to tension and shear loads

**Annex C 3**

Appendix 11/ 11